

Outdoor Wave-to-Open Sensors

- SD-9163-KSQ** Slimline, English*
- SD-9163-KSVQ** Slimline, English*, Manual Override
- SD-9263-KSQ** Single-Gang, English*
- SD-9263-KSVQ** Single-Gang, English*, Manual Override



The Outdoor Wave-to-Open Sensor is a full-featured exit plate which uses IR technology to allow egress from a protected area or activate a device with the simple wave of a hand. Since no touch is required, this sensor is suitable for use in hospitals, clinics, labs, cleanrooms (to reduce the risk of contamination), schools, factories, or offices.

Features

- ETL, Conforms to UL Std. 294
- Weather-resistant (IP65) for outdoor use†
- Clean and simple no-touch operation reduces the risk of cross-contamination
- Adjustable sensor range up to 7" (18cm)
- Stainless steel plate, available in slimline or single-gang
- 1.2A relay, adjustable trigger duration 0.8~30 seconds
- Selectable LED colors (turns from red to green or green to red) to show if the sensor is activated

SD-9163-KSVQ and SD-9263-KSVQ only

- Manual override button functions without electricity in case of power failure

Specifications

Model	SD-9163-KSQ	SD-9263-KSQ
	SD-9163-KSVQ	SD-9263-KSVQ
Operating voltage	12~24 VDC	
Current draw Standby (12/24 VDC)	13mA / 15mA	18mA / 23mA
(max. ±10%) Triggered (12/24 VDC)	23mA / 28mA	28mA / 35mA
Relay type	Form C dry contact, 1.2A@24VDC	
Response time	10mS	
Output time	0.8~30s, toggle	
Range	2"~7' (5~18cm)	
IP Rating	IP65†	
Operating temperature	-4°~131° F (-20°~55° C)	
Dimensions	11/2"x41/2"x11/2" (39x115x39 mm)	223/4"x41/2"x11/2" (70x115x39 mm)

*Also available with Spanish or French faceplates

†When properly installed.

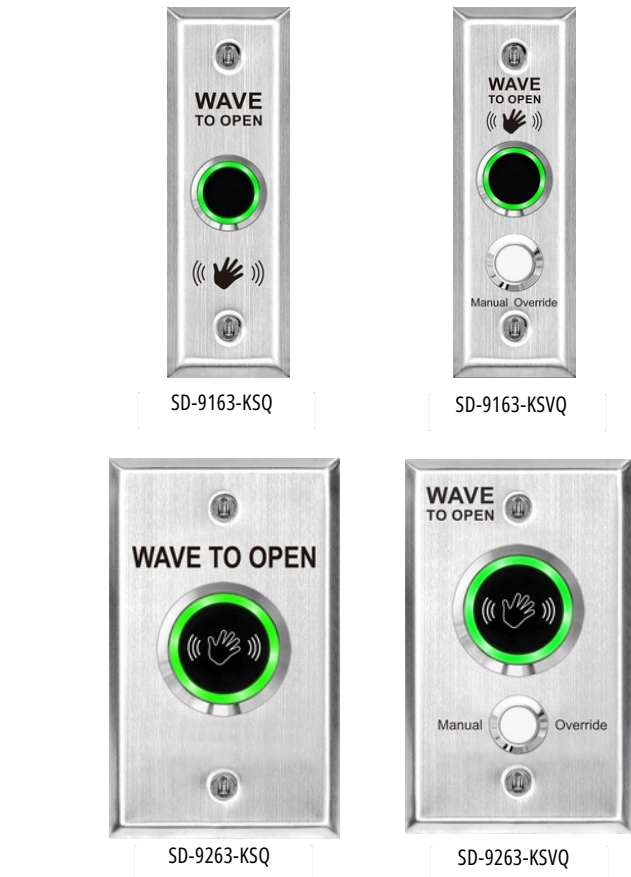

Sample Installation

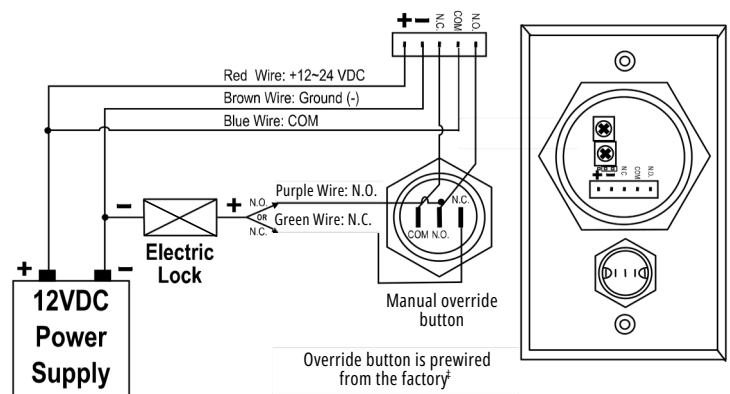

‡SD-9163-KSVQ and SD 9263-KSVQ only







ASCENDO PTE LTD

85 Playfair Road
#06-02, Tong Yuan Industrial Building
Singapore 368000



Tel: 6741 1218
sales@ascendo.com.sg
www.ascendo.com.sg

Outdoor Wave-to-Open Sensors



Ordering Information

Outdoor Wave-to-Open Sensors*						
Model	SD-9163-KSQ	SD-9263-KSQ	SD-9163-KS1Q	SD-9263-KS1Q	SD-9163-KS2Q	SD-9263-KS2Q
Language	English		Spanish		French	
Photo						

*Also available with European faceplate in English, Spanish, and French models

Outdoor Wave-to-Open Sensors with Override Button			
Model	SD-9163-KSVQ	SD-9263-KSVQ	SD-9463-KSVQ
Language	English†		
Photo			

†Spanish and French faceplates available by special order

Outdoor Wave-to-Open Sensors – Other Models			Other Models Also Available For our full line of OEM/private label infrared sensors, contact SECO-LARM
Model	SD-9963-KSGQ	SD-9773-KNEVQ	
Type	Post-Mount	Surface-Mount	
Photo			

ASCENDO PTE LTD

**85 Playfair Road
#06-02, Tong Yuan Industrial Building
Singapore 368000**

**Tel: 6741 1218
sales@ascendo.com.sg
www.ascendo.com.sg**